

Product data sheet

Characteristics

XU5N18PP341D

Photoelectric sensors XU, XU5, diffuse, Sn 0.10 m, 12...24 VDC, M12



Product availability: Non-Stock - Not normally stocked in distribution facility

Price*: 107.00 USD



Main

Range of Product	Telemecanique Photoelectric sensors XU
Series name	Application food and beverage
Electronic sensor type	Photo-electric sensor
Sensor name	XU5
Sensor design	Cylindrical M18
Detection system	Diffuse
Material	Stainless steel
Line of sight type	Axial
Type of output signal	Discrete
Supply circuit type	DC
Wiring Technique	3-wire
Discrete output type	PNP
Discrete output function	1 NO or 1 NC programmable
Electrical connection	1 male connector M12, 4 pins
Product Specific Application	-
Emission	Infrared diffuse
[Sn] nominal sensing distance	0.33 Ft (0.1 m) diffuse

Complementary

Enclosure Material	Stainless steel : 304 CU
Lens material	PMMA
Maximum sensing distance	0.49 Ft (0.15 m)
Output Type	Solid state
Add on output	Without
Add on input	Programmation
Status LED	1 LED green)supply on 1 LED yellow)output state
[Us] rated supply voltage	12...24 V DC with reverse polarity protection
Supply voltage limits	10...30 V DC

Switching capacity in mA	<= 100 mA overload and short-circuit protection)
Switching frequency	<= 500 Hz
Maximum voltage drop	<1.5 V closed state)
Current consumption	<= 30 mA no-load
Maximum delay first up	15 Ms
Maximum delay response	1 Ms
Maximum delay recovery	1 Ms
Setting-up	Without sensitivity adjustment
Diameter	0.71 In (18 mm)
Length	2.83 In (72 mm)
Net Weight	0.14 Lb(US) (0.065 kg)

Environment

Product Certifications	CE CSA UL
Ambient air temperature for operation	-13...131 °F (-25...55 °C)
Ambient Air Temperature for Storage	-40...158 °F (-40...70 °C)
Vibration resistance	25 gn +/- 1.5 mm 10...55 Hz) IEC 60068-2-6
Shock resistance	30 gn 11 ms) IEC 60068-2-27
IP degree of protection	IP67 conforming to IEC 60529



Ordering and shipping details

Category	22481 - SENSORS, PHOTOELECTRIC
Discount Schedule	DS2
GTIN	03389110853728
Nbr. of units in pkg.	1
Package weight(Lbs)	2.40 Oz (68 g)
Returnability	No
Country of origin	FR

Packing Units

Unit Type of Package 1	PCE
Package 1 Height	2.60 In (6.6 cm)
Package 1 width	3.70 In (9.4 cm)
Package 1 Length	1.65 In (4.2 cm)
Unit Type of Package 2	S01
Number of Units in Package 2	11
Package 2 Weight	34.46 Oz (977 g)
Package 2 Height	5.91 In (15 cm)
Package 2 width	5.91 In (15 cm)
Package 2 Length	15.75 In (40 cm)

Offer Sustainability

Sustainable offer status	Green Premium product
California proposition 65	WARNING: This product can expose you to chemicals including: Diisononyl phthalate (DINP), which is known to the State of California to cause cancer, and Diisodecyl phthalate (DIDP), which is known to the State of California to cause birth defects or other reproductive harm. For more information go to www.P65Warnings.ca.gov
REACH Regulation	 REACH Declaration
EU RoHS Directive	Pro-active compliance (Product out of EU RoHS legal scope)  EU RoHS Declaration
Mercury free	Yes

RoHS exemption information	Yes
Environmental Disclosure	Product Environmental Profile
Circularity Profile	End Of Life Information

Contractual warranty

Warranty	18 months
----------	-----------

Dimensions

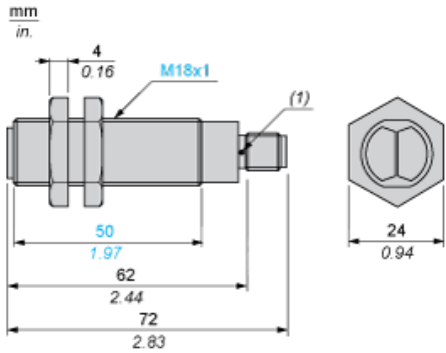

(1) LED

Mounting and Clearance

Fixing nut tightening torque: < 15 N.m

Connector tightening torque: 2 N.m

Wiring Schemes

M12 Connector

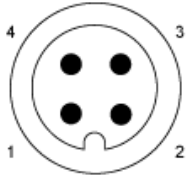

- 3: (-)
- 1: (+)
- 4: OUT/Output
- 2: Prog

3-wire, PNP NO or NC Programmable Function

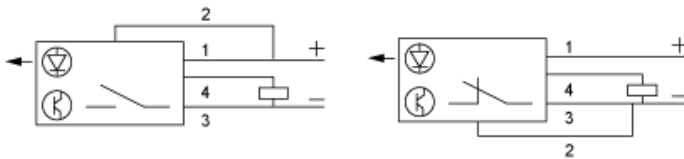

Detection Curves

Diffuse System

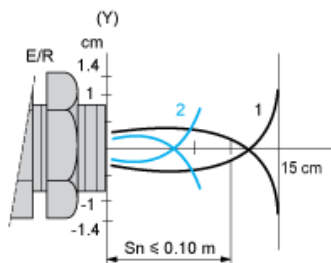

(y) \varnothing of beam
1 : White 90%
2 : Grey 18%
Object 10 x 10 cm

Excess Gain Curves (Ambient Temperature: + 25° C)

Diffuse System

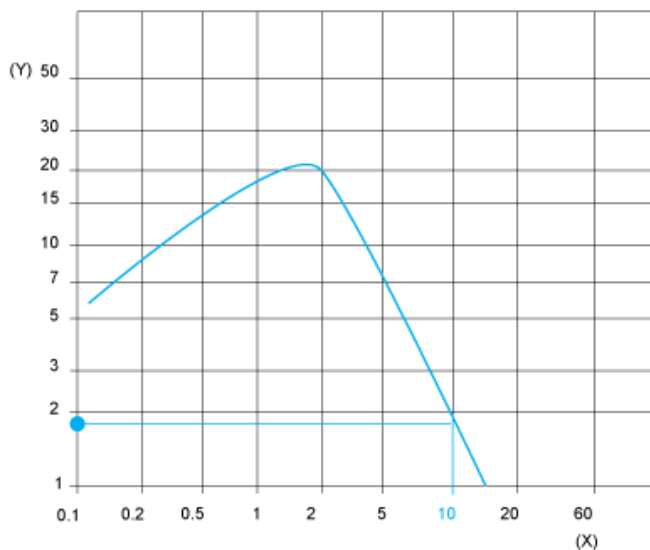

(y) Gain
(x) Distance (m)
Object 10 x 10 cm
White 90%

Product Life Status : **Commercialised**